

NOTE: (NBM) = NOT BY MORIN

NOTE:  
DOORS, LOUVERS & WINDOWS BY OTHERS  
(SEALANT BY OTHERS)

PANEL CLIP

Morin

INTEGRITY SERIES PANELS  
VERTICAL APPLICATION

X-12 PROFILE

DWG. ISV1000E



25"  
8"  
4"  
150°

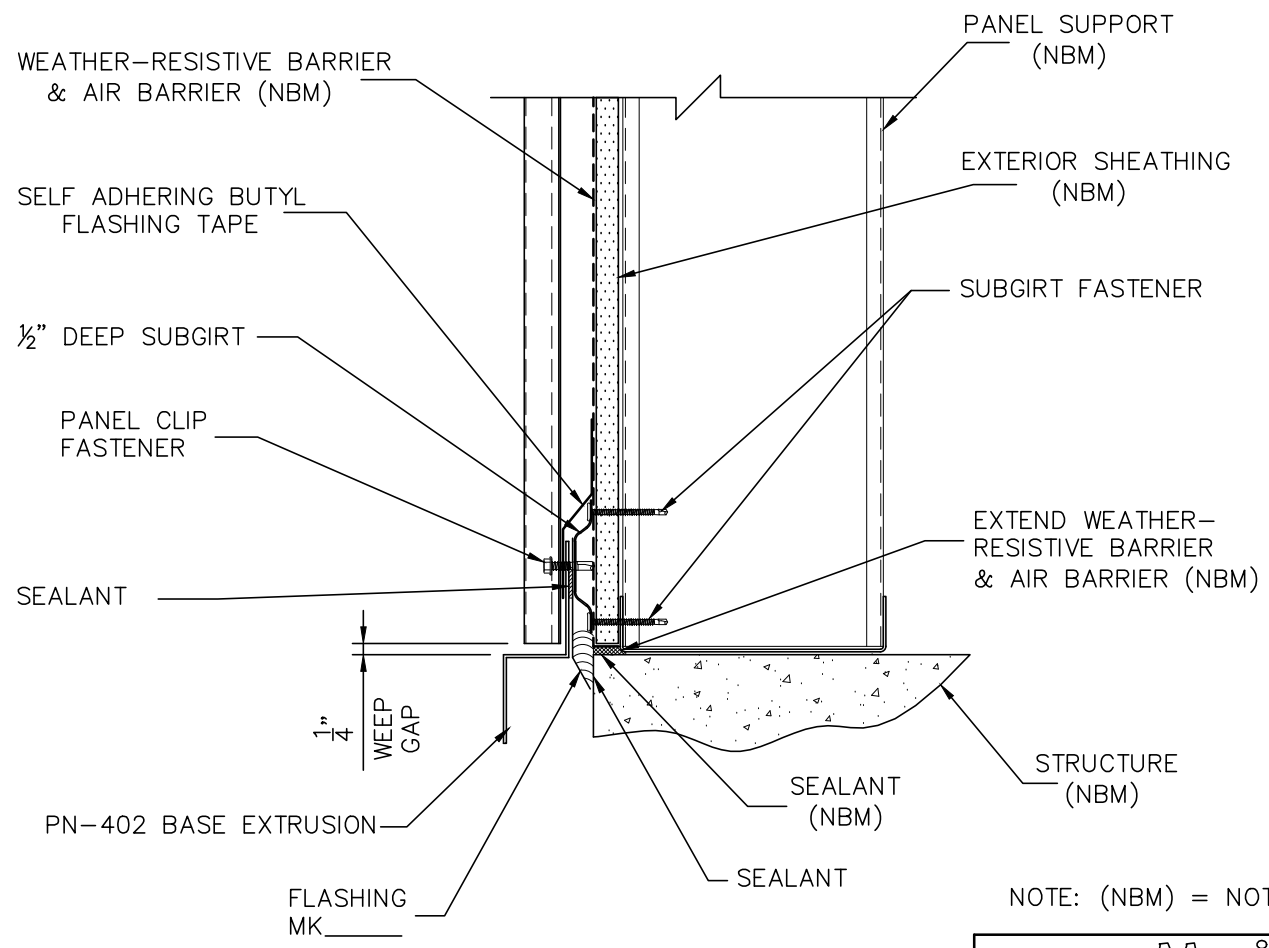

NOTE: (NBM) = NOT BY MORIN

<b>Morin</b>	
<b>INTEGRITY SERIES PANELS</b>	
<b>VERTICAL APPLICATION</b>	
X-12 PROFILE	
DWG. ISV1001E	



2"  
1"  
108° 15"  
2  
16

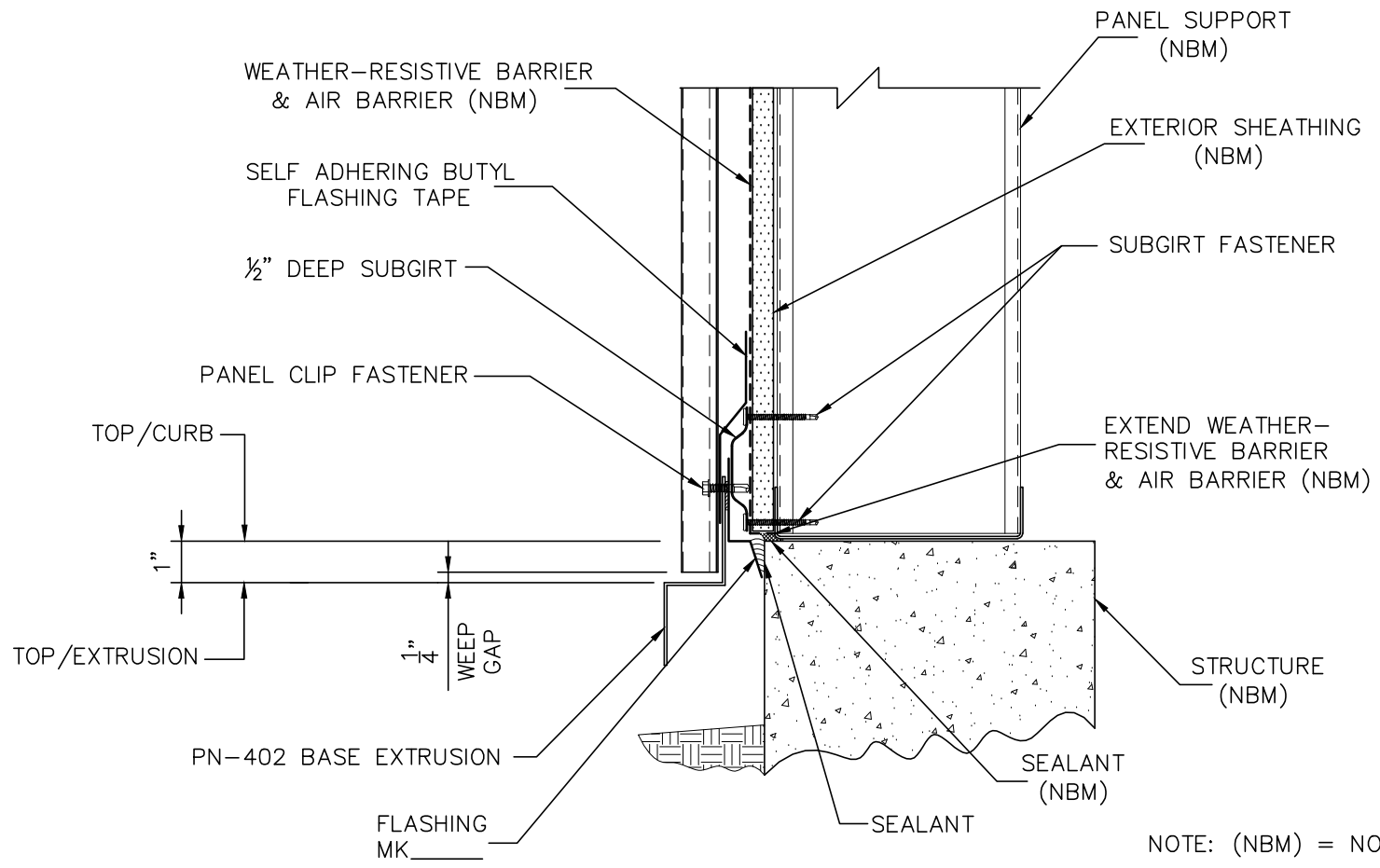

NOTE: (NBM) = NOT BY MORIN

<b>Morin</b>	
<b>INTEGRITY SERIES PANELS</b>	
<b>VERTICAL APPLICATION</b>	
X-12 PROFILE	
DWG. ISV1002E	



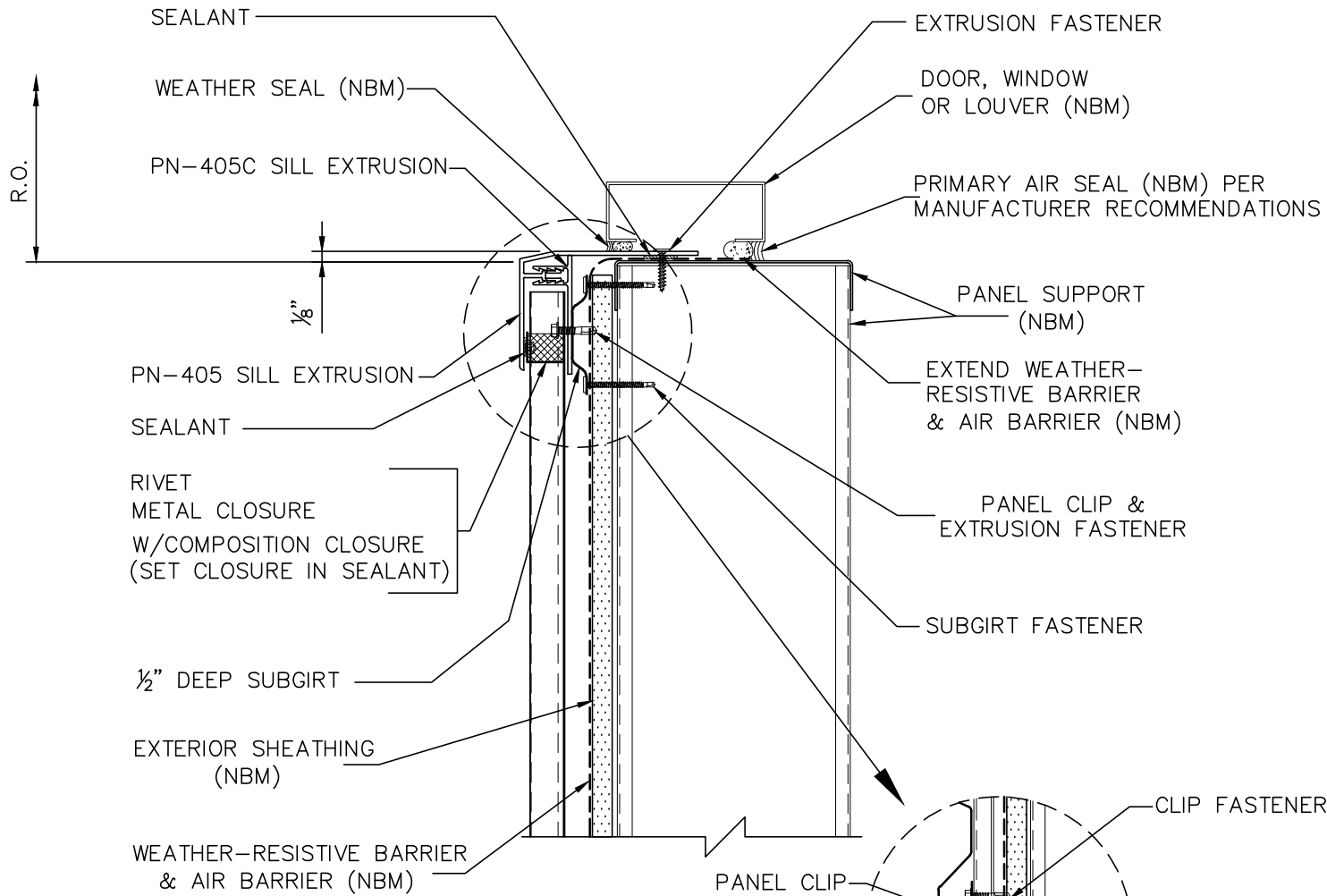

NOTE:  
DOORS, LOUVERS AND WINDOWS BY OTHERS  
(SEALANT BY OTHERS)

NOTE: (NBM) = NOT BY MORIN

**Morin**

**INTEGRITY SERIES PANELS  
VERTICAL APPLICATION**

X-12 PROFILE

DWG. ISV1003E



**PANEL CLIP**

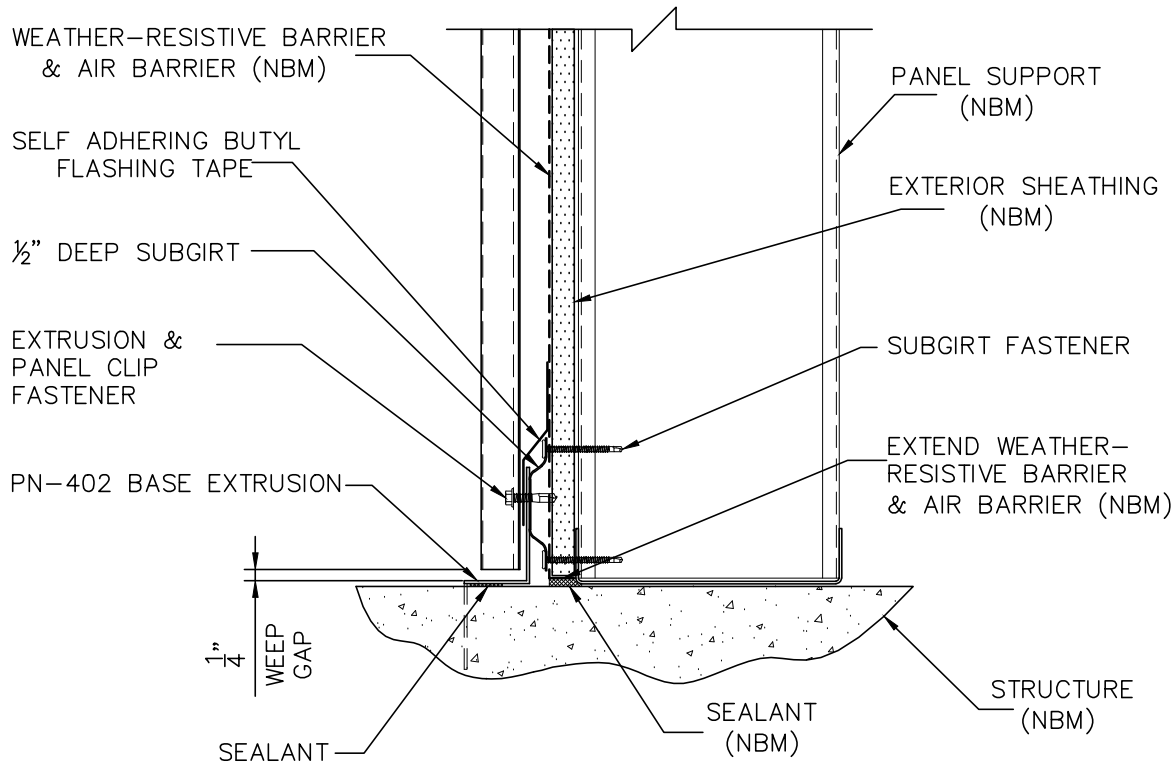

NOTE: (NBM) = NOT BY MORIN

Morin

INTEGRITY SERIES PANELS  
VERTICAL APPLICATION

X-12 PROFILE

DWG. ISV1004E



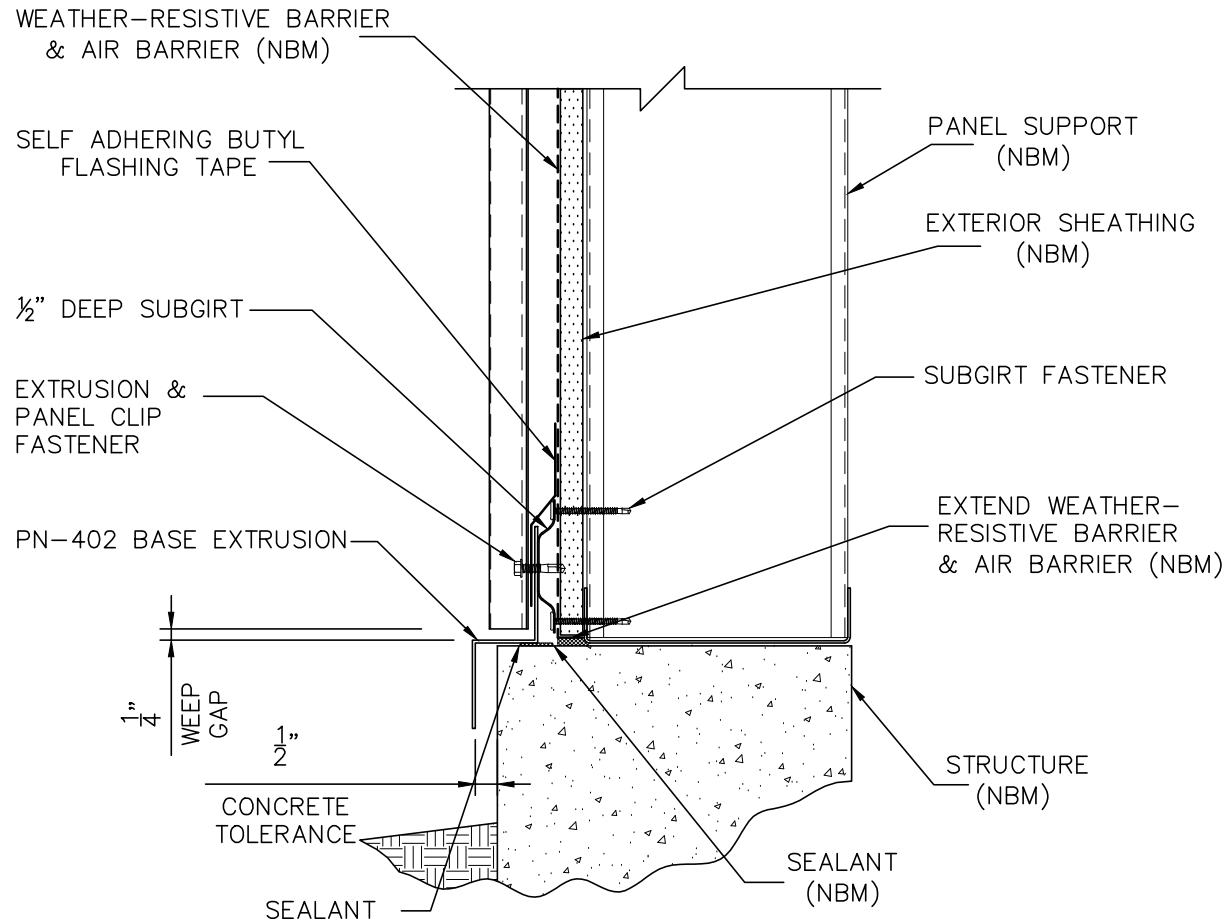

NOTE: (NBM) = NOT BY MORIN

Morin

INTEGRITY SERIES PANELS  
VERTICAL APPLICATION

X-12 PROFILE

DWG. ISV1005E



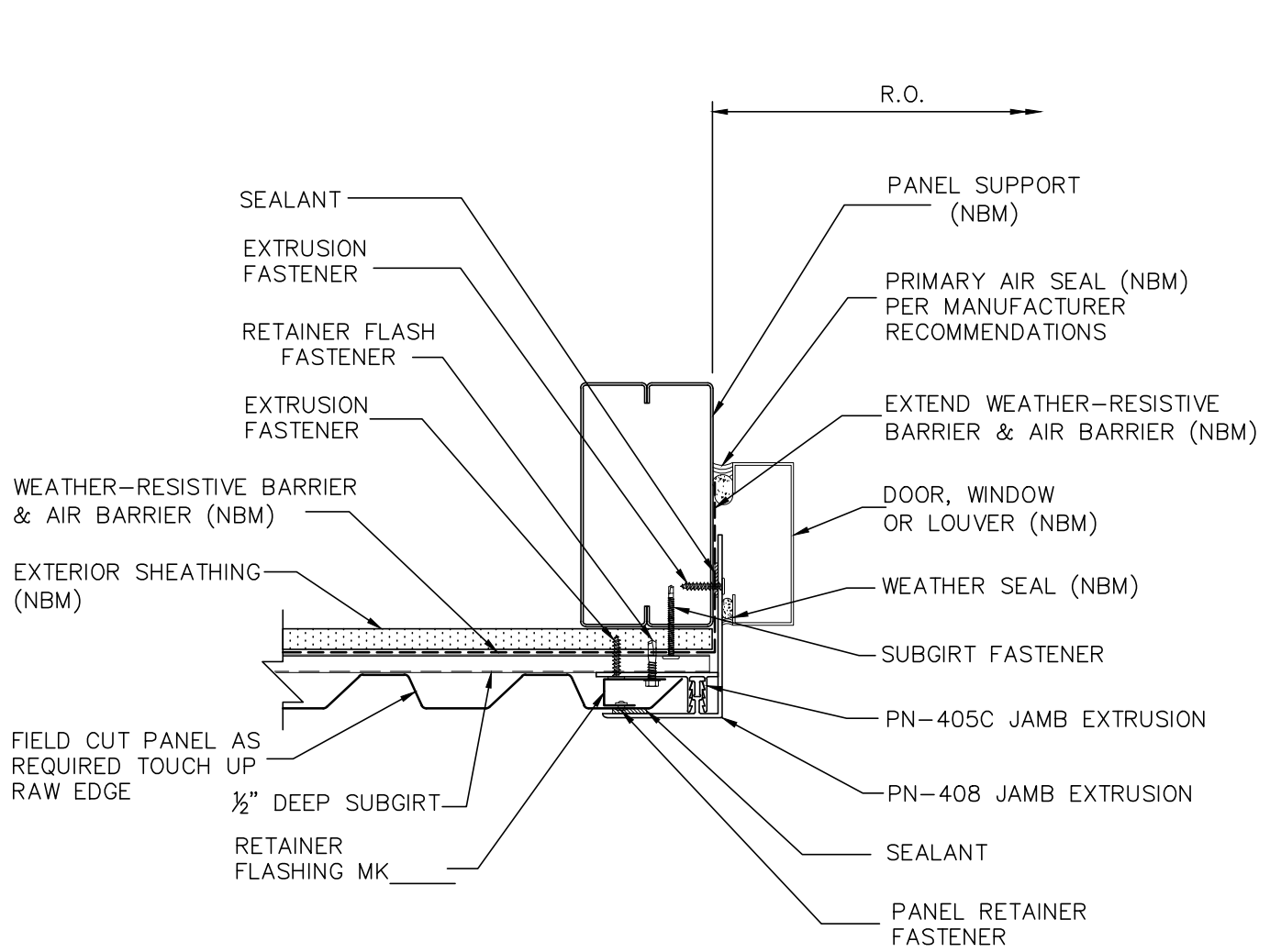

NOTE: (NBM) = NOT BY MORIN

<b>Morin</b>	
<b>INTEGRITY SERIES PANELS</b>	
<b>VERTICAL APPLICATION</b>	
X-12 PROFILE	
DWG. ISV1006E	

NOTE:  
DOORS, LOUVERS & WINDOWS BY OTHERS  
(SEALANT BY OTHERS)

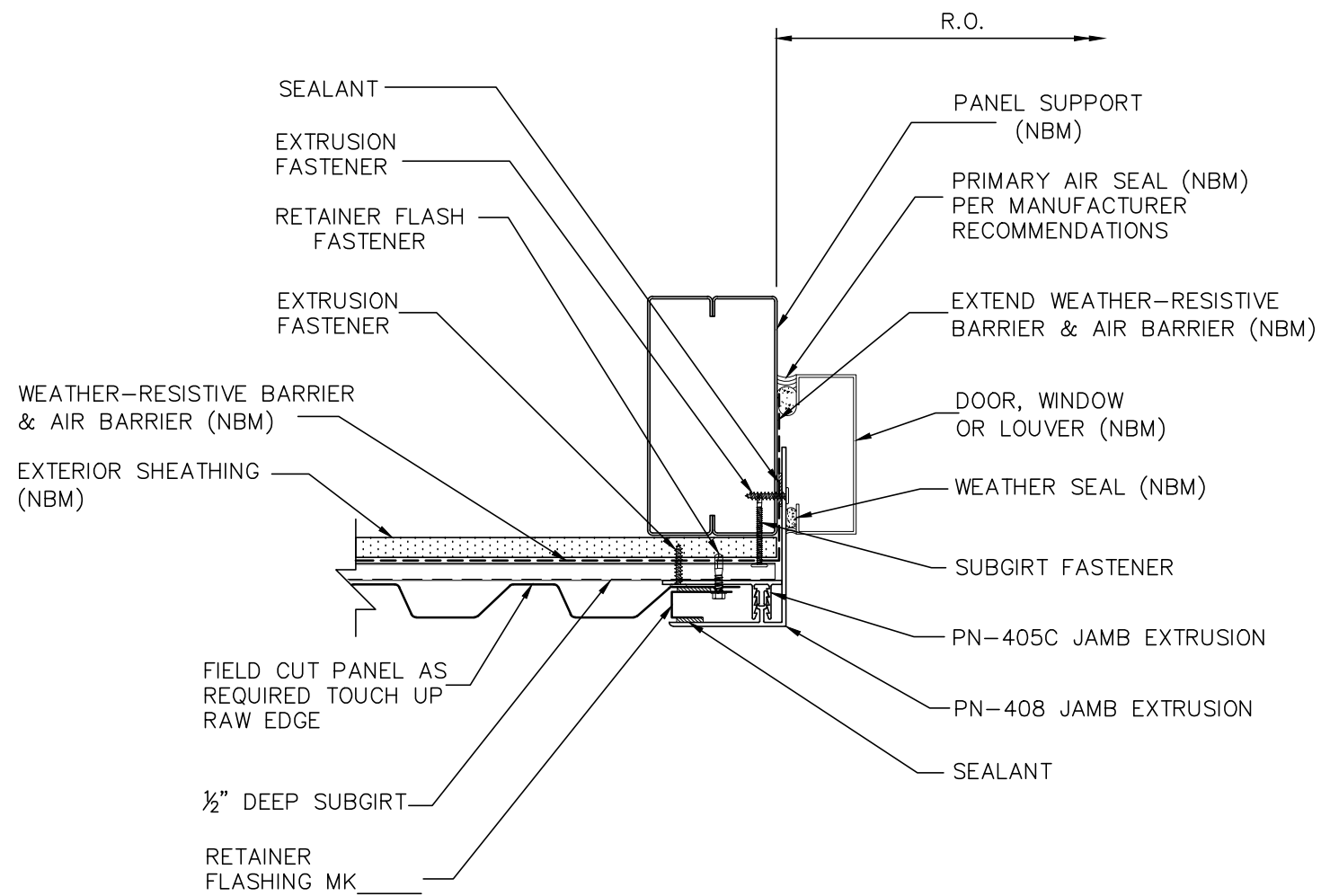
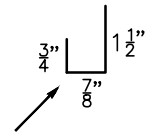

NOTE: (NBM) = NOT BY MORIN

NOTE:  
DOORS, LOUVERS & WINDOWS BY OTHERS  
(SEALANT BY OTHERS)

<b>Morin</b>	
<b>INTEGRITY SERIES PANELS</b>	
<b>VERTICAL APPLICATION</b>	
X-12 PROFILE	
DWG. ISV1007E	



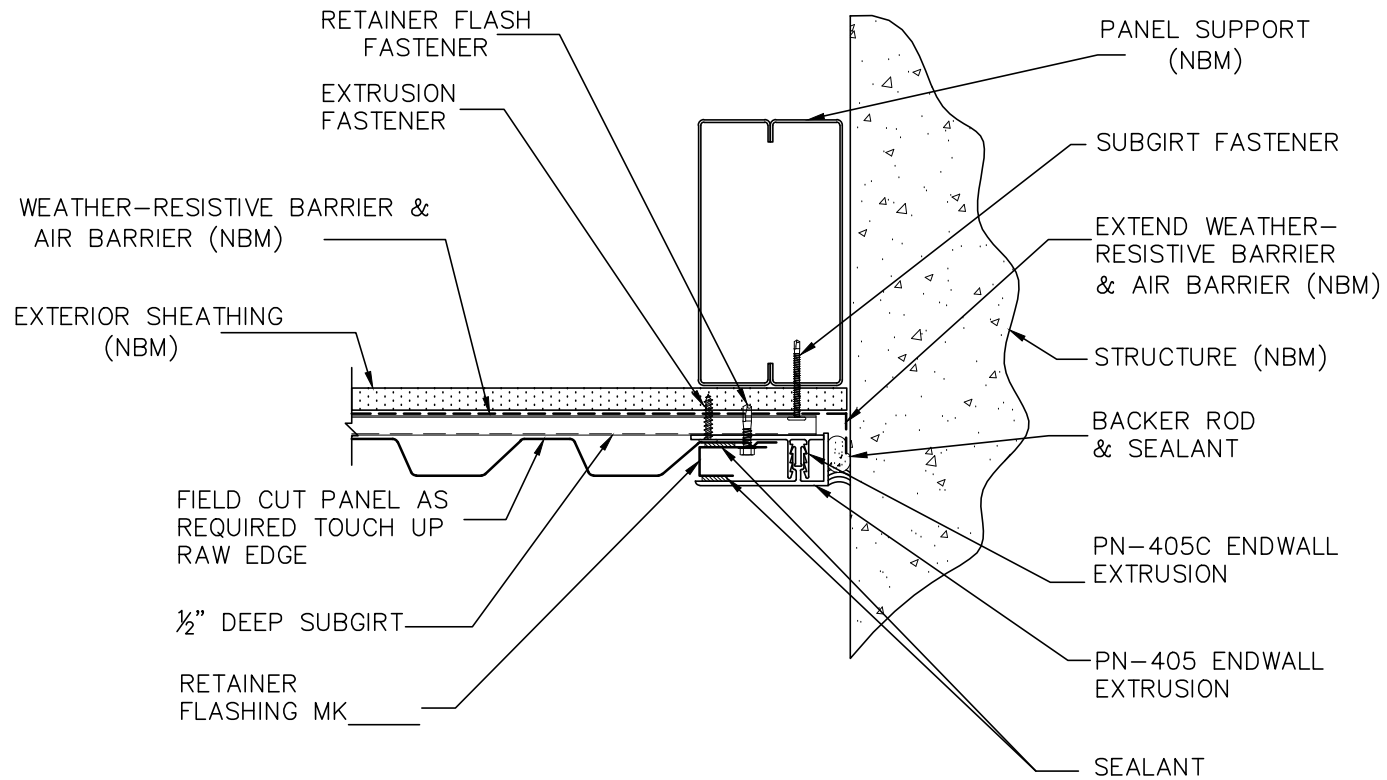
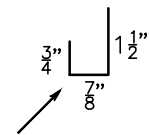

NOTE: (NBM) = NOT BY MORIN

Morin

INTEGRITY SERIES PANELS  
VERTICAL APPLICATION

X-12 PROFILE

DWG. ISV1008E



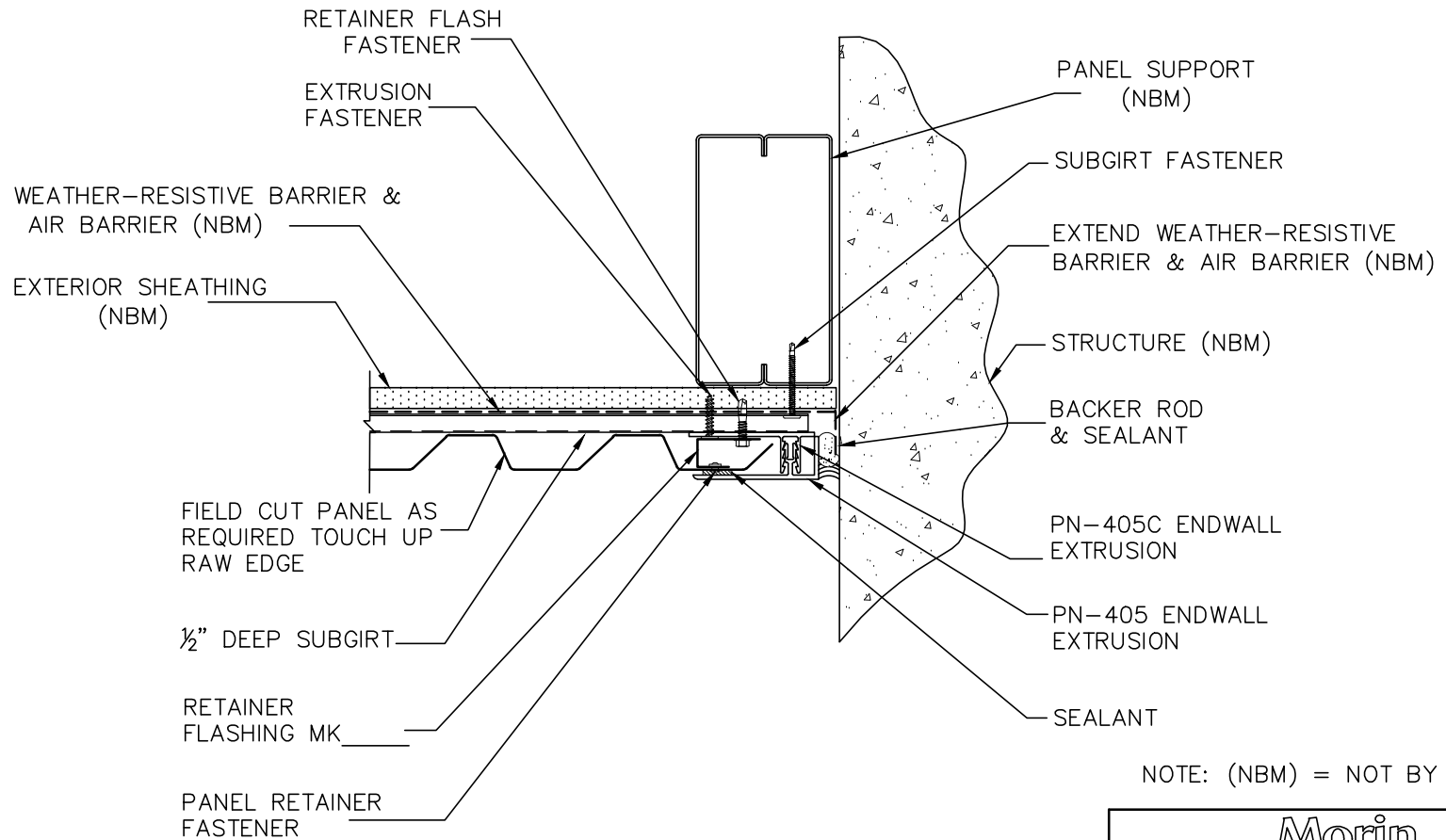
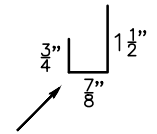

NOTE: (NBM) = NOT BY MORIN

<b>Morin</b>	
<b>INTEGRITY SERIES PANELS</b> <b>VERTICAL APPLICATION</b>	
X-12 PROFILE	
DWG. ISV1009E	

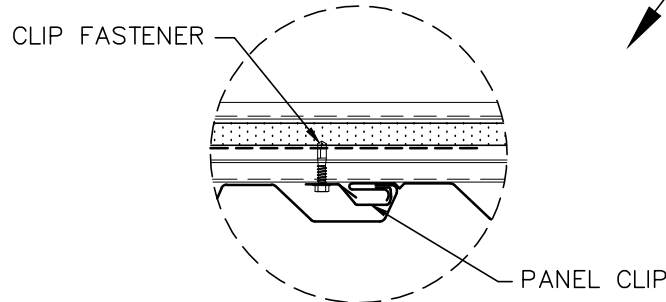
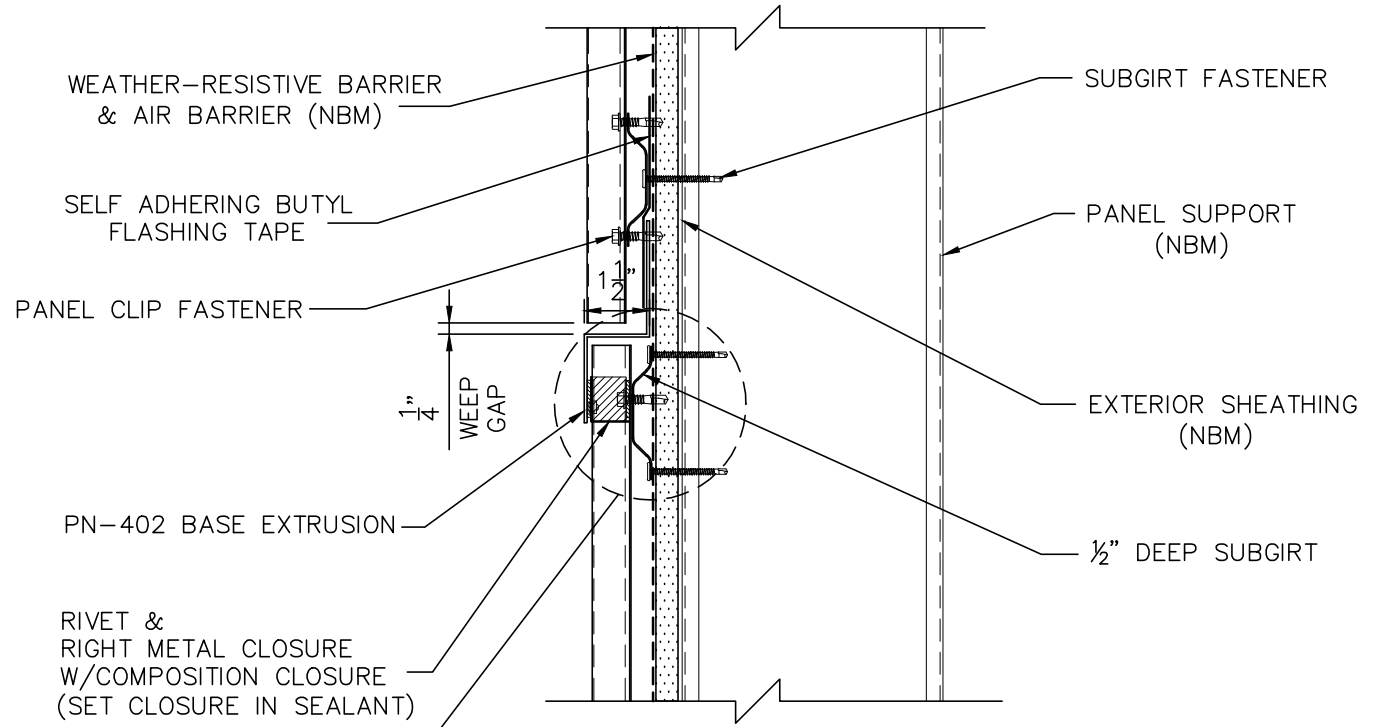

PANEL CLIP

NOTE: (NBM) = NOT BY MORIN

<i>Morin</i>	
<u>INTEGRITY SERIES PANELS</u> <u>VERTICAL APPLICATION</u>	
X-12 PROFILE	
DWG. ISV1010E	

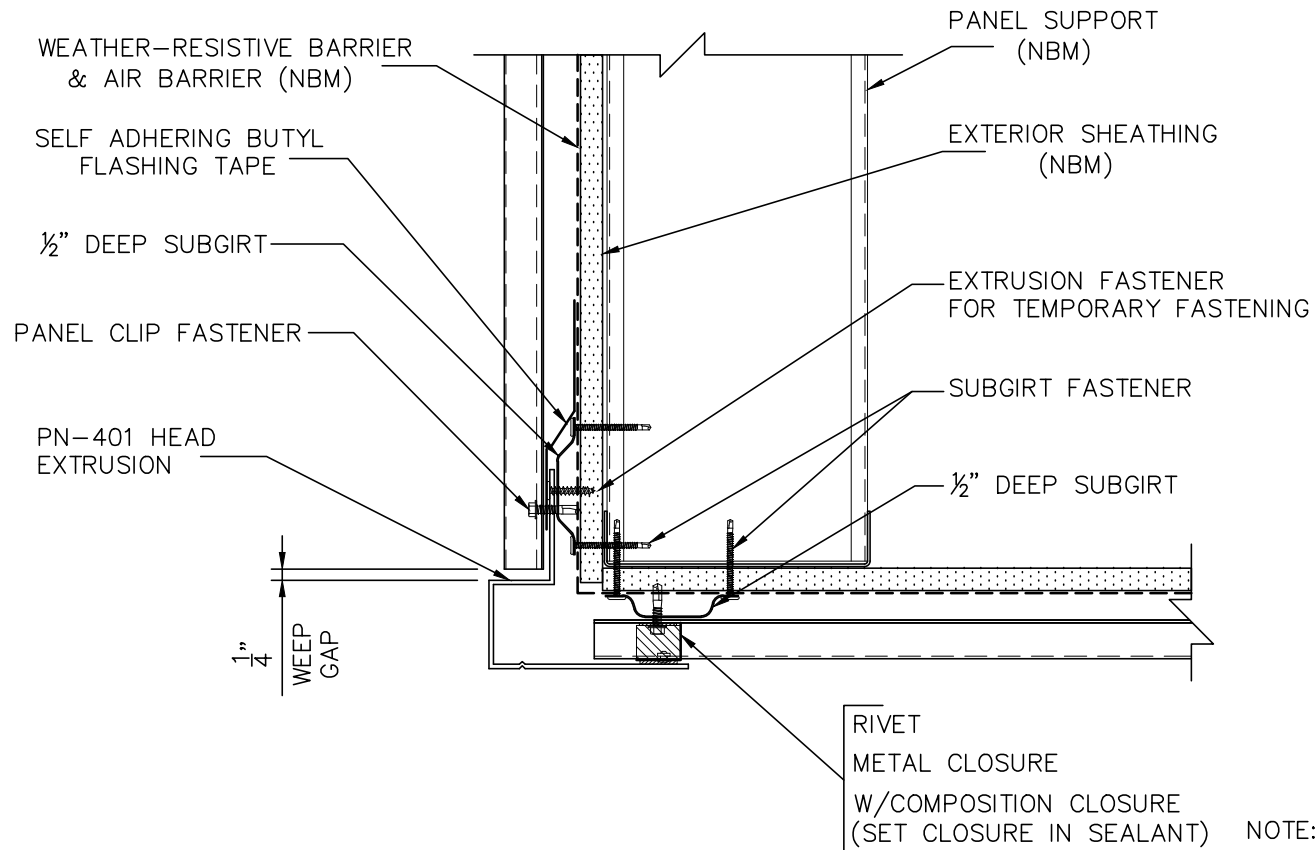

NOTE: (NBM) = NOT BY MORIN

Morin

INTEGRITY SERIES PANELS  
VERTICAL APPLICATION

X-12 PROFILE

DWG. ISV1011E



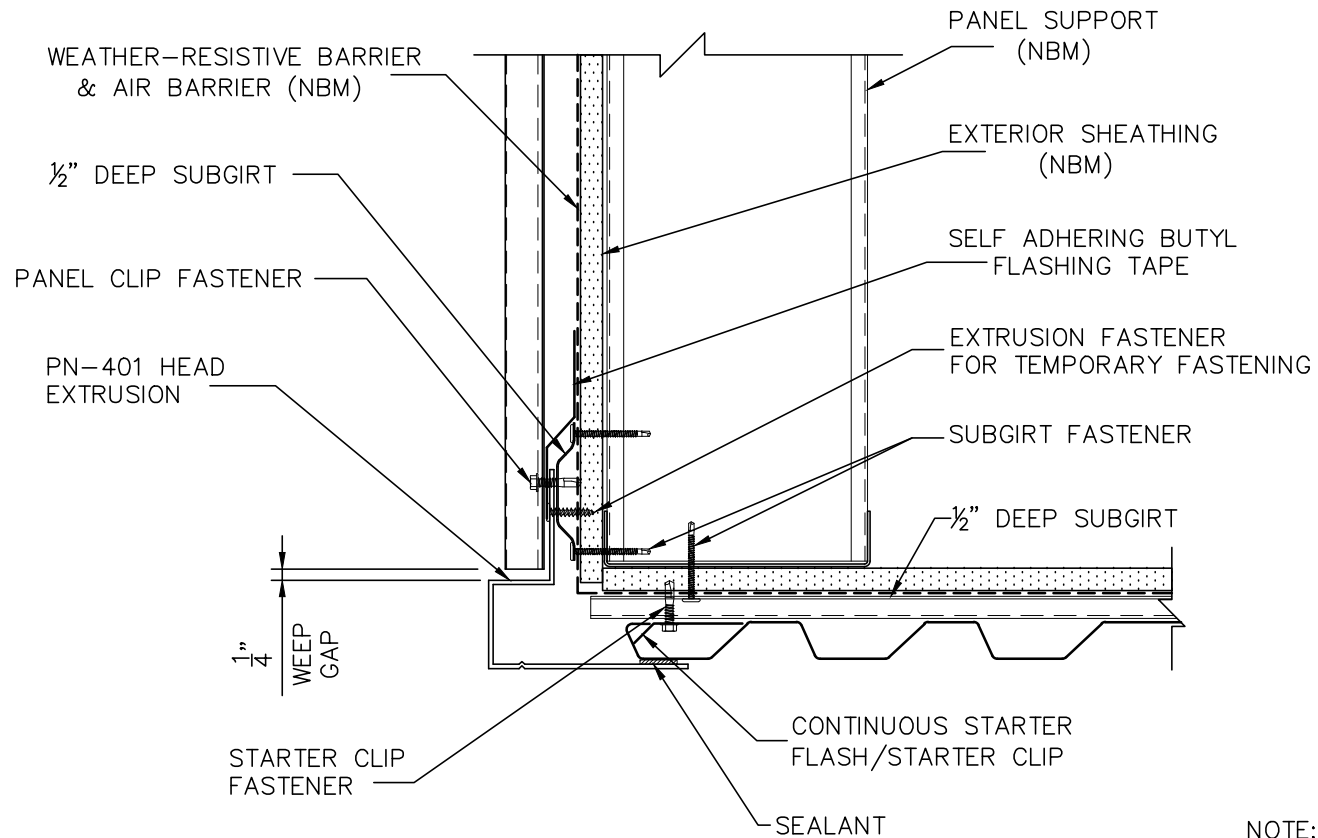

NOTE: (NBM) = NOT BY MORIN

Morin

INTEGRITY SERIES PANELS  
VERTICAL APPLICATION

X-12 PROFILE

DWG. ISV1012E



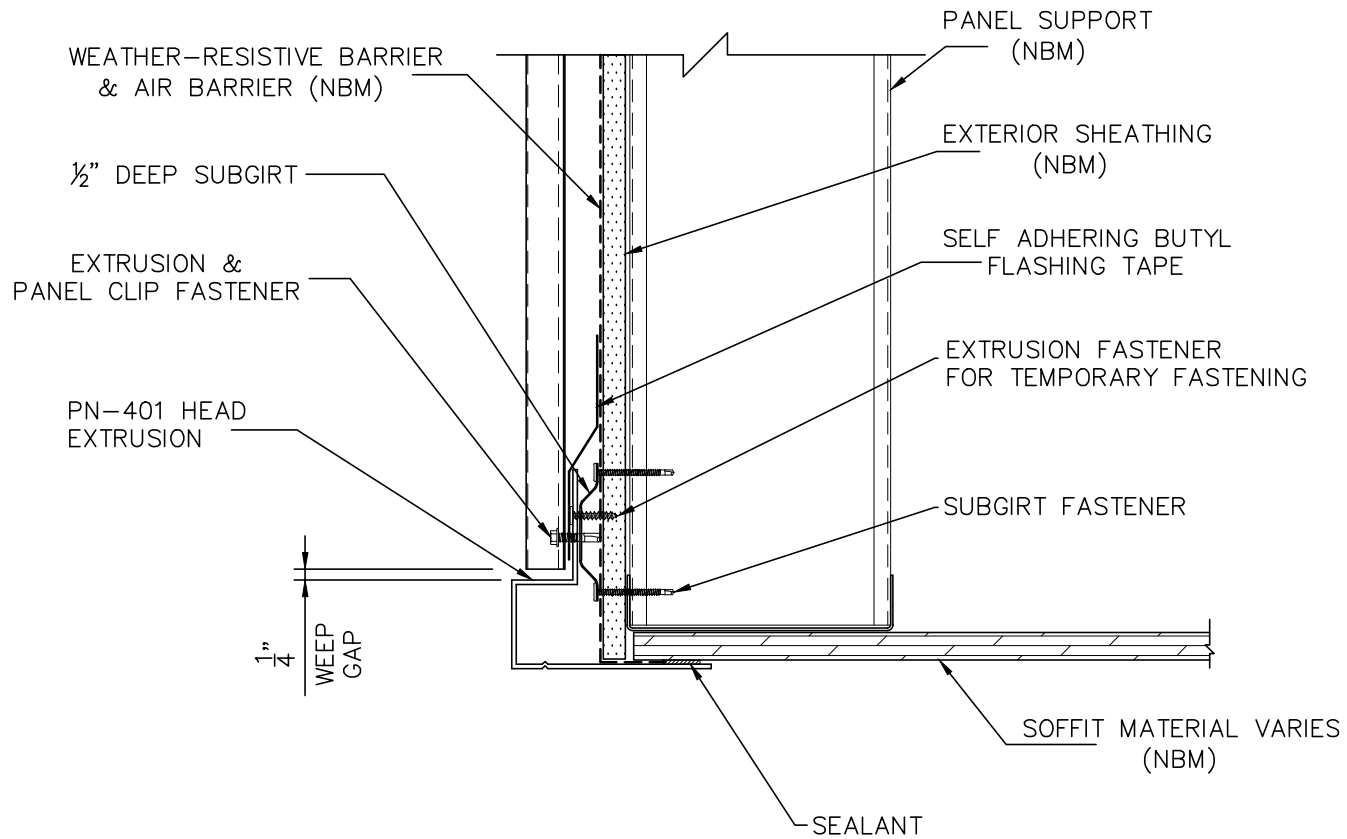

NOTE: (NBM) = NOT BY MORIN

Morin

INTEGRITY SERIES PANELS  
VERTICAL APPLICATION

X-12 PROFILE

DWG. ISV1013E



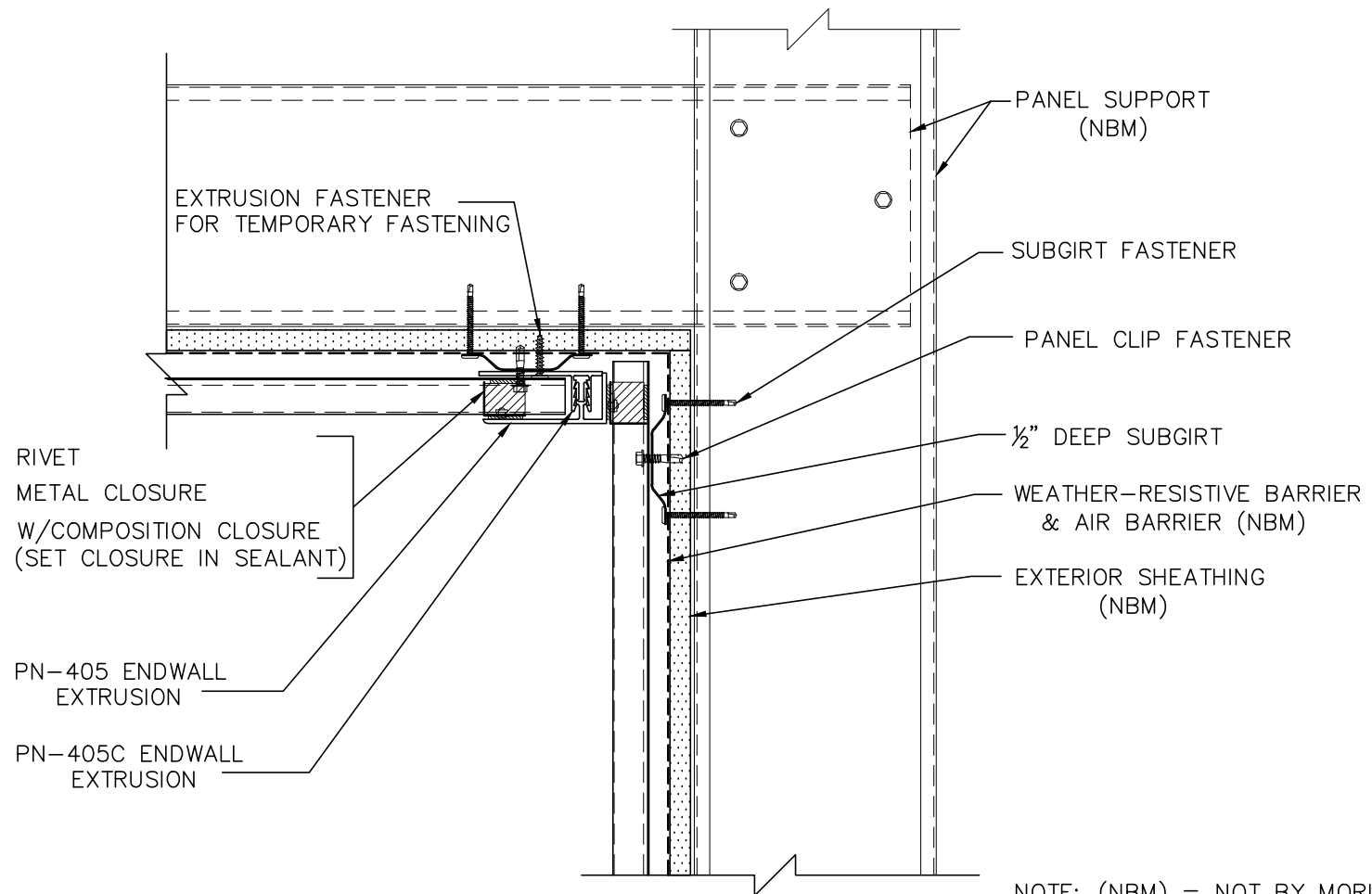

NOTE: (NBM) = NOT BY MORIN

Morin

INTEGRITY SERIES PANELS  
VERTICAL APPLICATION

X-12 PROFILE

DWG. ISV1014E



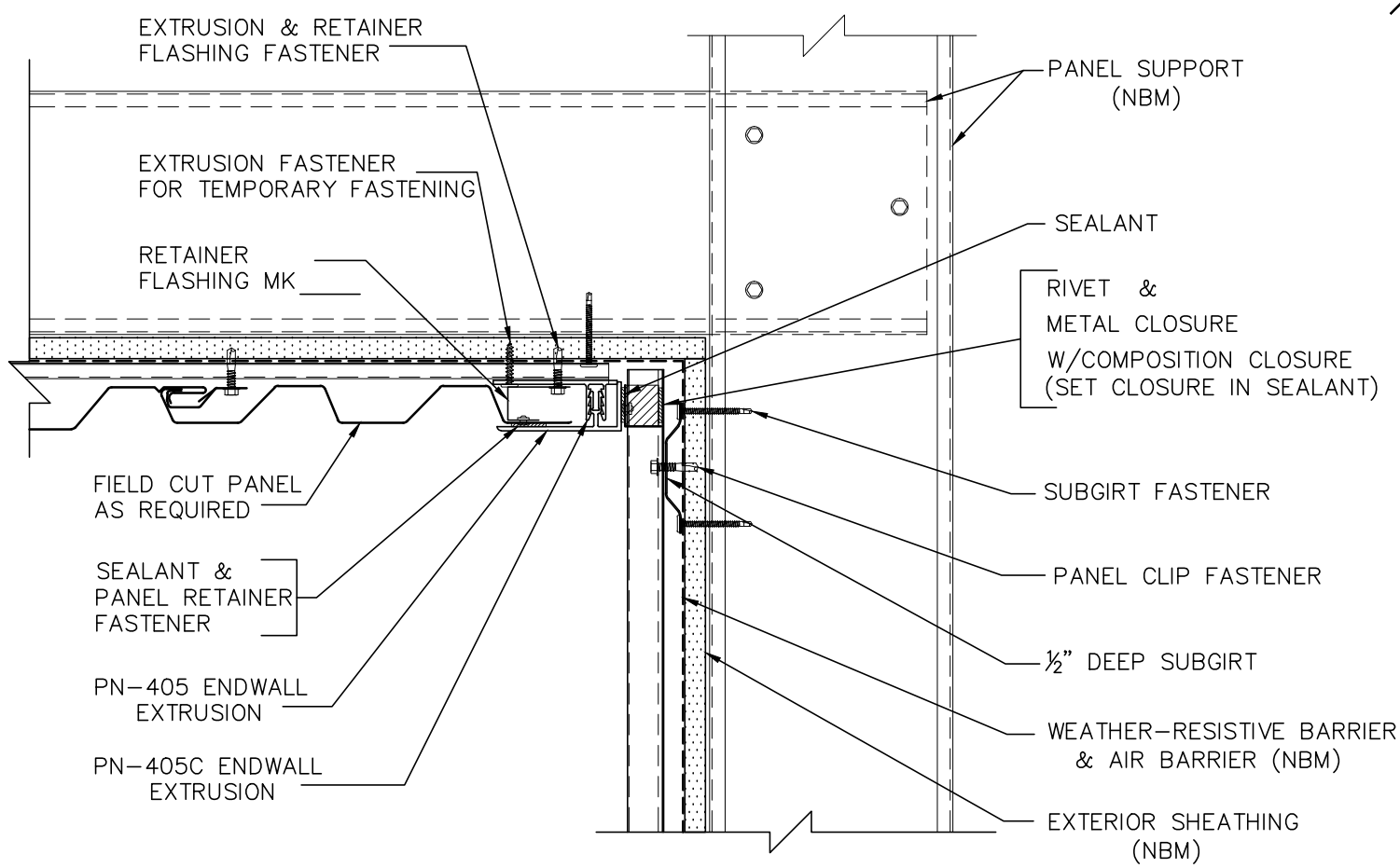
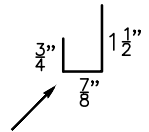

NOTE: (NBM) = NOT BY MORIN

<b>Morin</b>	
<b>INTEGRITY SERIES PANELS</b>	
<b>VERTICAL APPLICATION</b>	
X-12 PROFILE	
DWG. ISV1015E	
△	



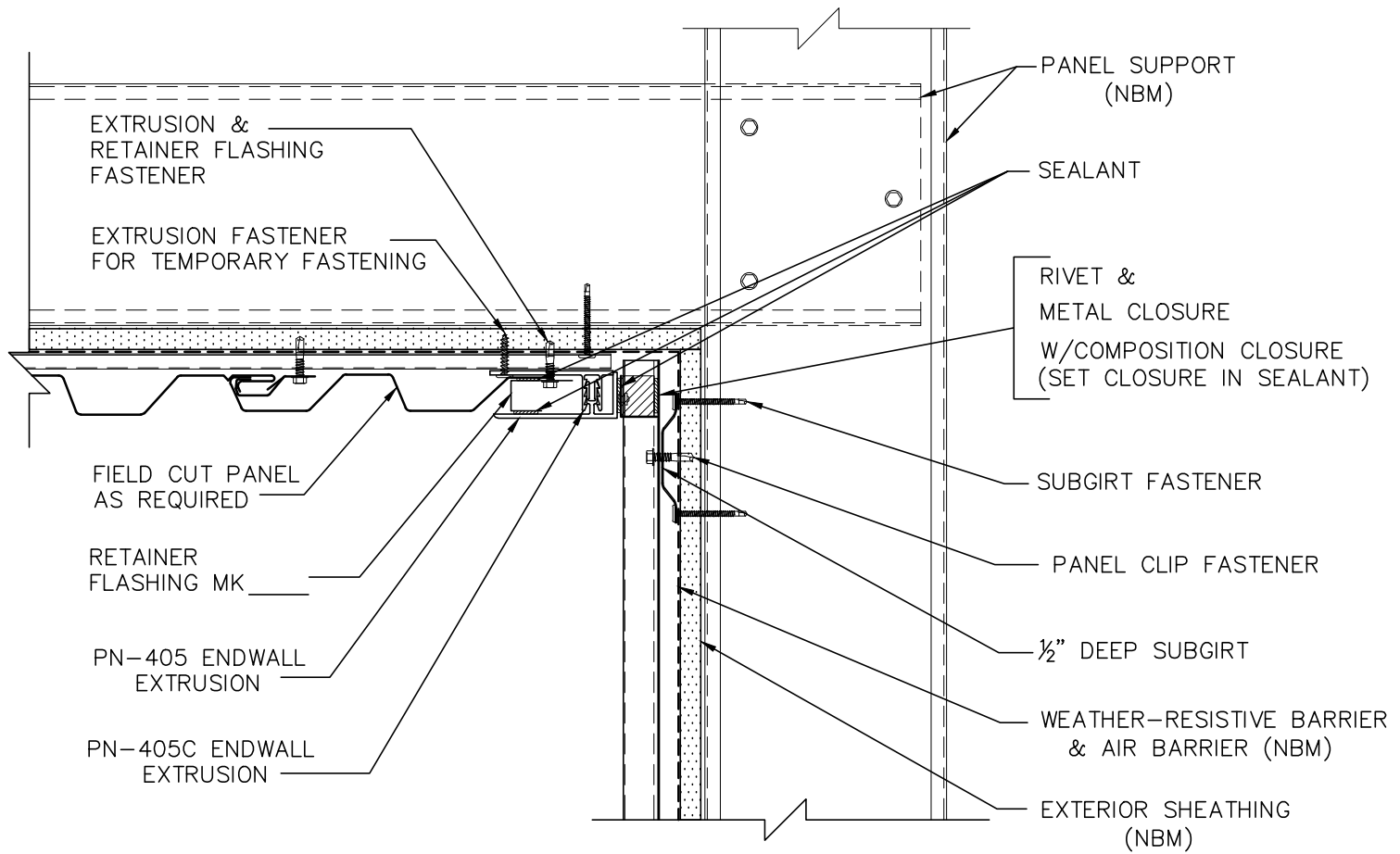
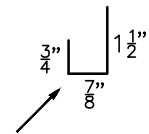

NOTE: (NBM) = NOT BY MORIN

<i>Morin</i>	
<u>INTEGRITY SERIES PANELS</u> <u>VERTICAL APPLICATION</u>	
X-12 PROFILE	
DWG. ISV1016E	

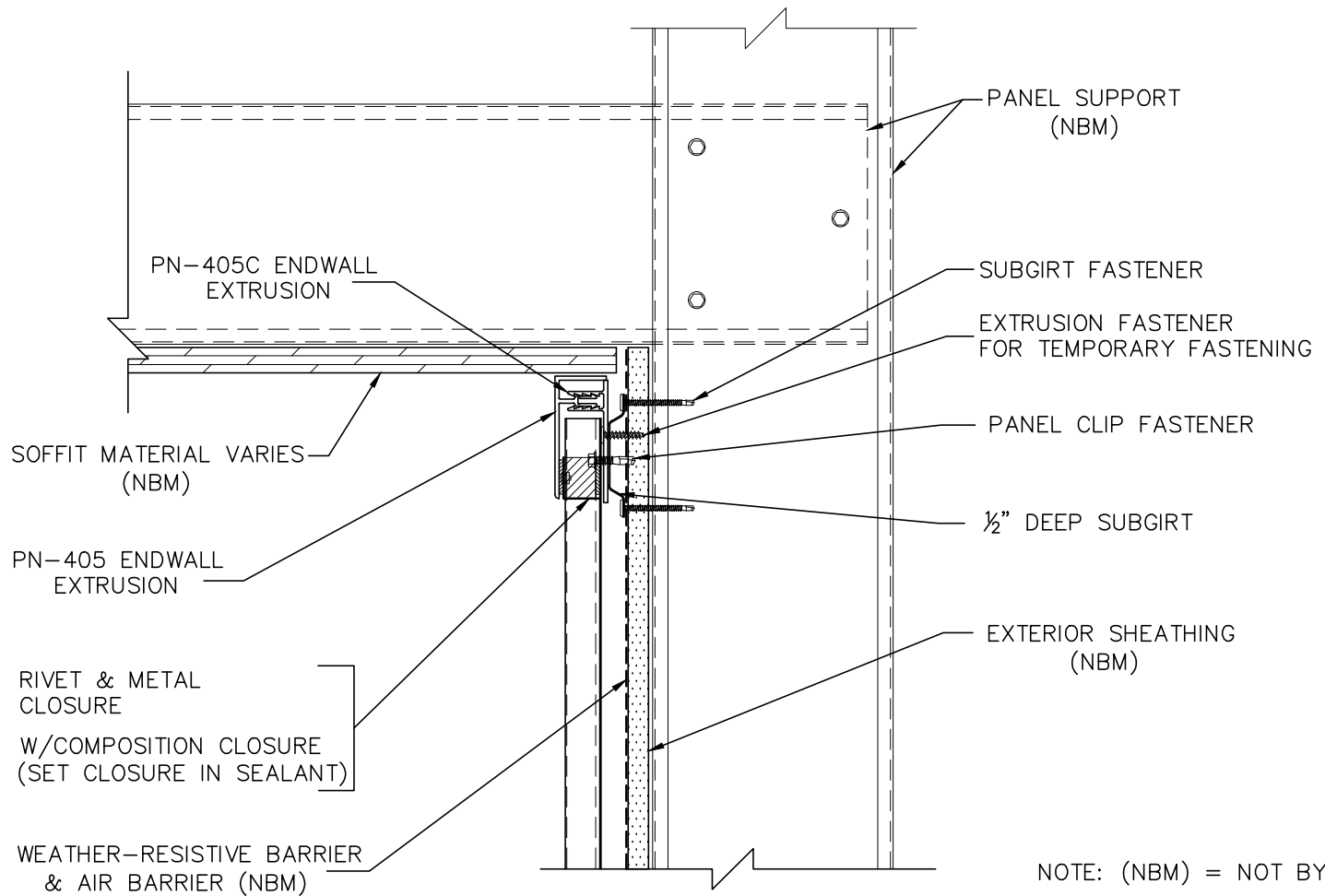

NOTE: (NBM) = NOT BY MORIN

<i>Morin</i>	
<u>INTEGRITY SERIES PANELS</u> <u>VERTICAL APPLICATION</u>	
X-12 PROFILE	
DWG. ISV1017E	

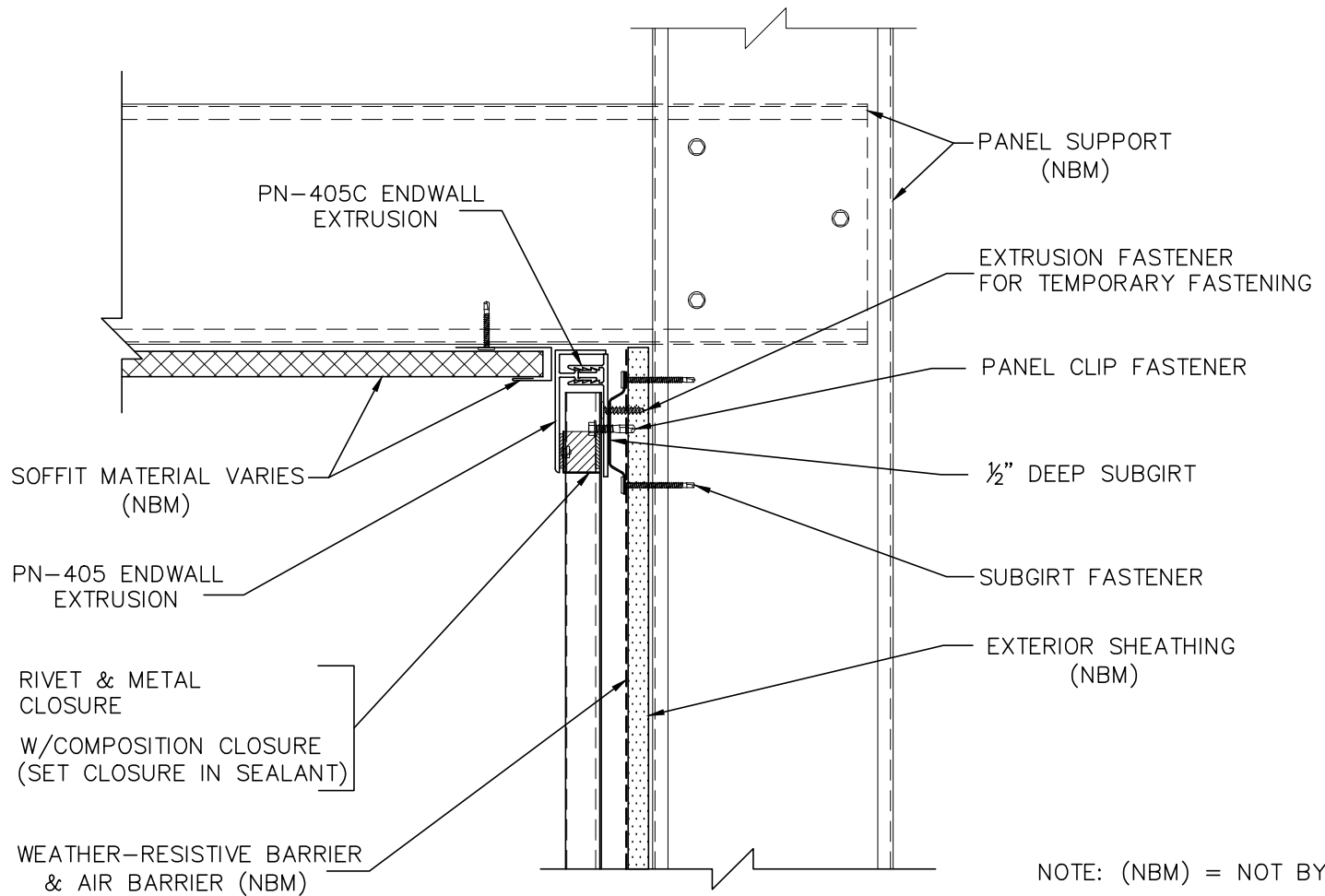

NOTE: (NBM) = NOT BY MORIN

<i>Morin</i>	
<u>INTEGRITY SERIES PANELS</u> <u>VERTICAL APPLICATION</u>	
X-12 PROFILE	
DWG. ISV1018E	

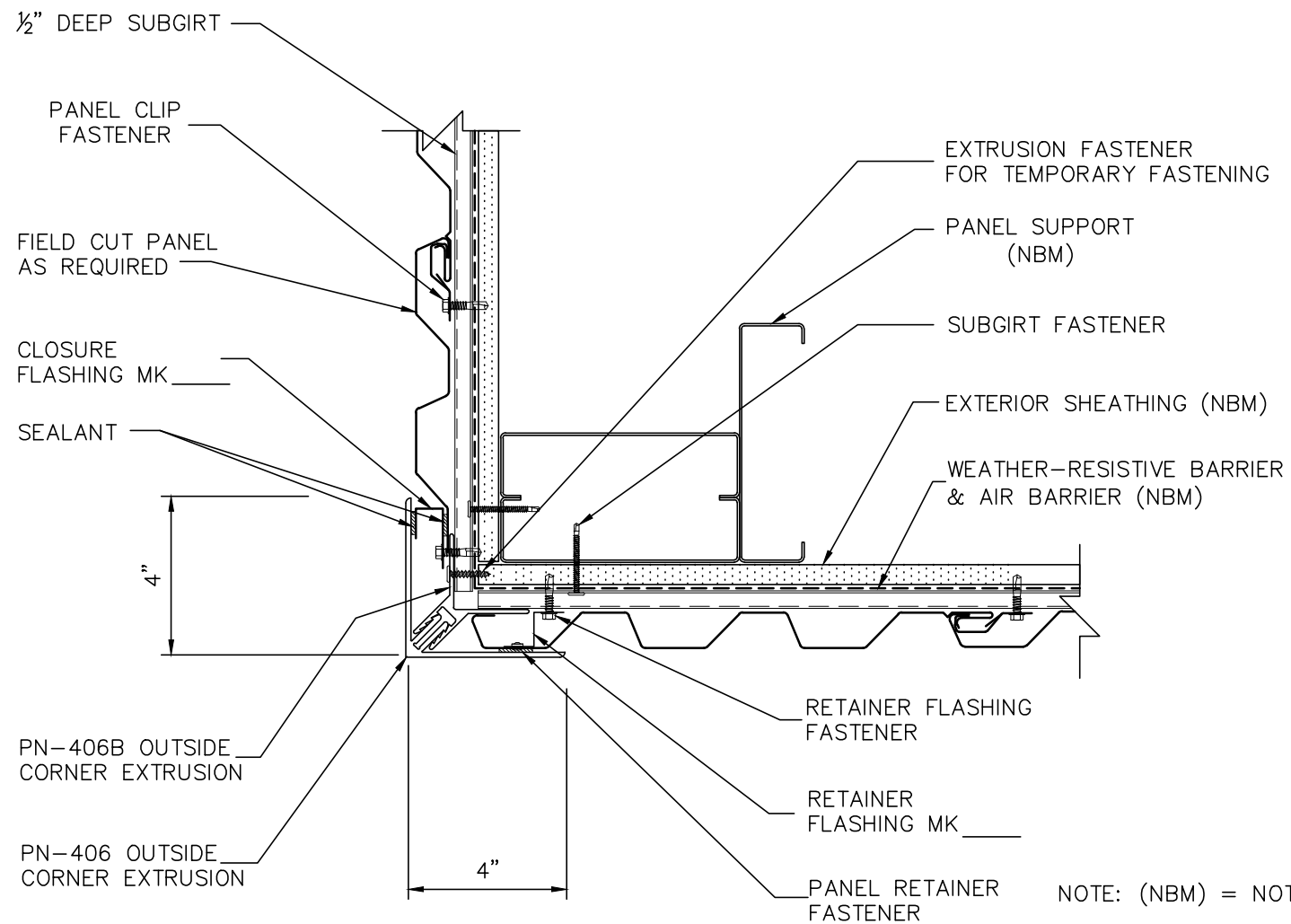
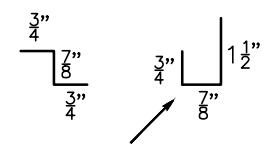

NOTE: (NBM) = NOT BY MORIN

<b>Morin</b>	
<b>INTEGRITY SERIES PANELS</b>	
<b>VERTICAL APPLICATION</b>	
X-12 PROFILE	
DWG. ISV1019E	



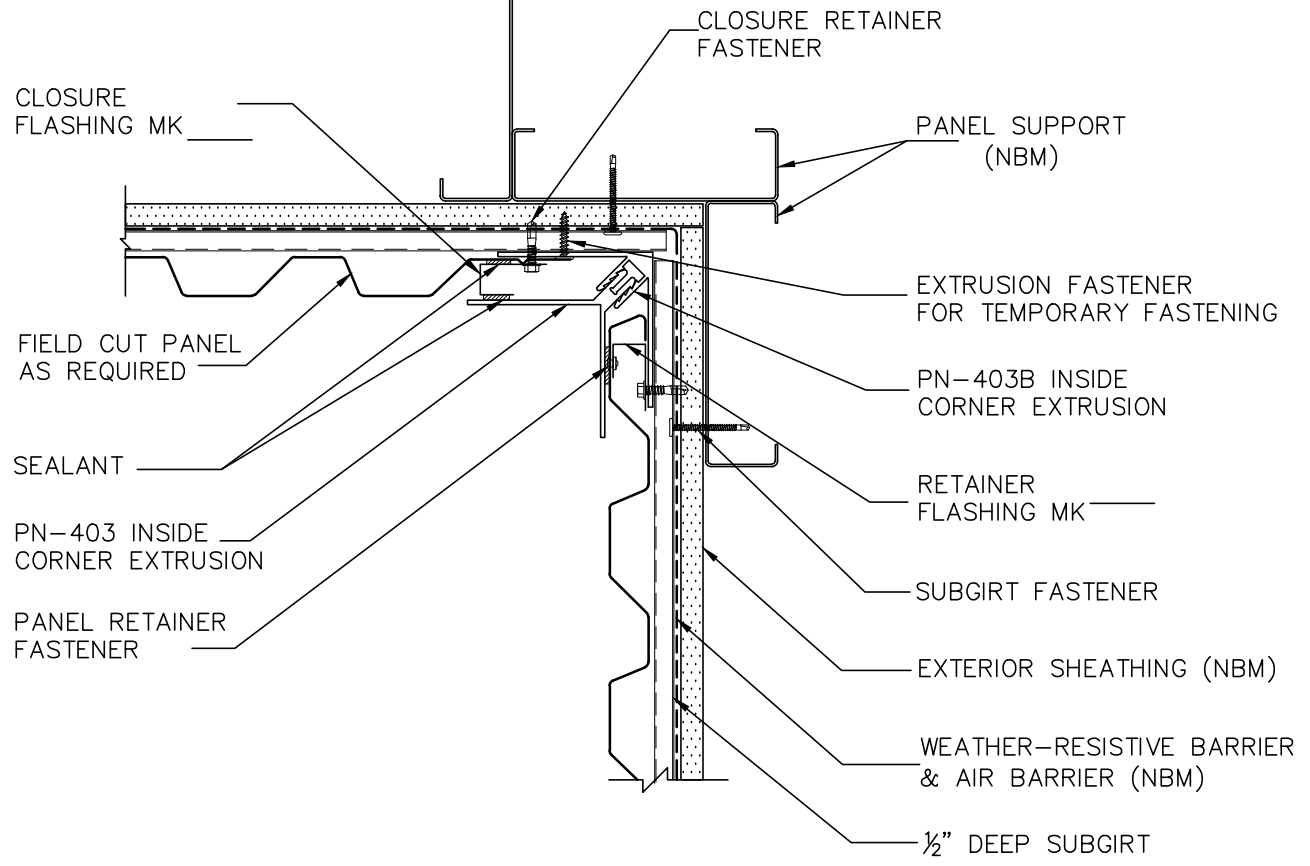
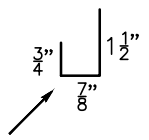

NOTE: (NBM) = NOT BY MORIN

<i>Morin</i>	
<u>INTEGRITY SERIES PANELS</u> <u>VERTICAL APPLICATION</u>	
X-12 PROFILE	
DWG. ISV1020E	

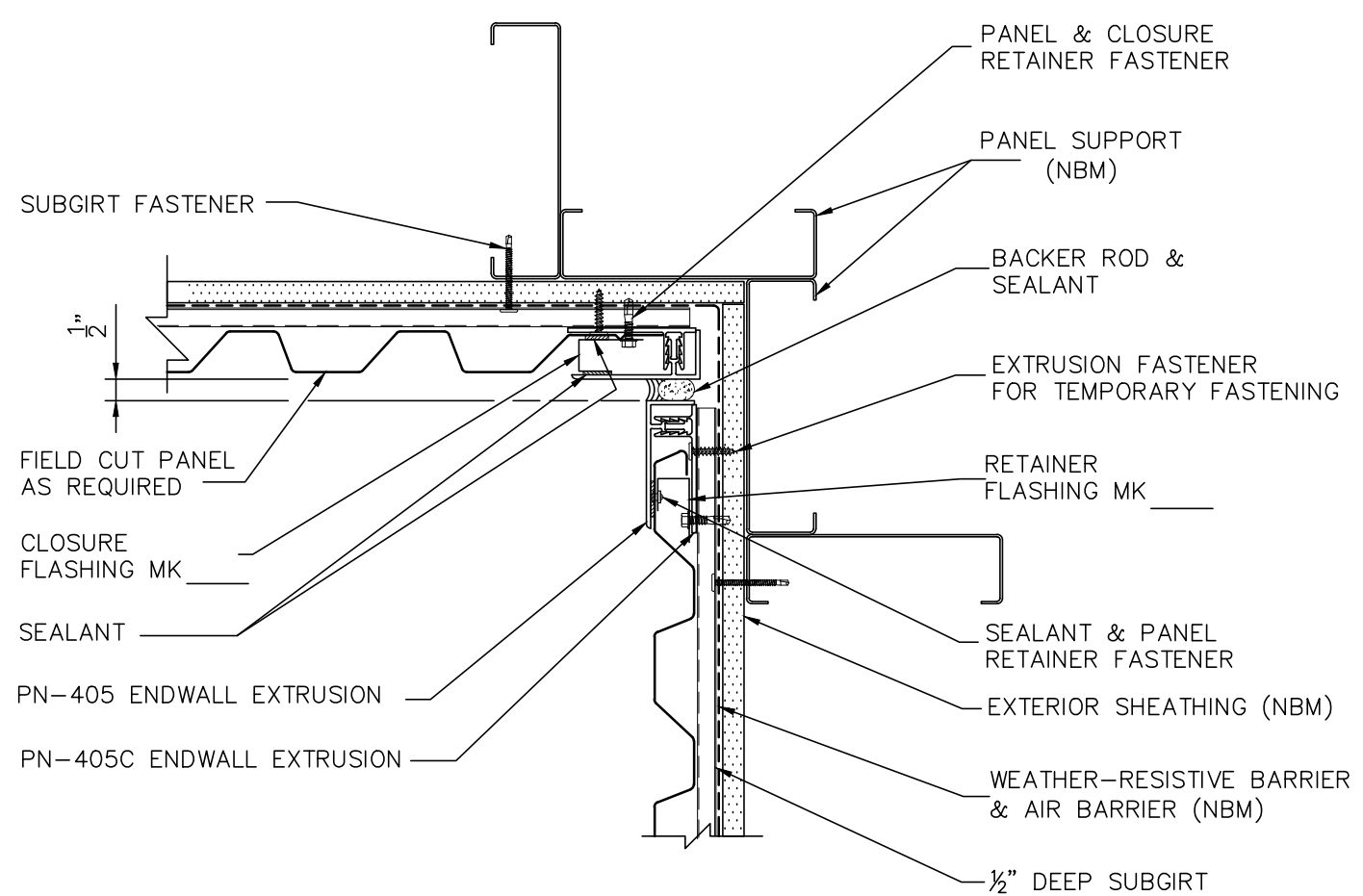
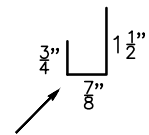

NOTE: (NBM) = NOT BY MORIN

<i>Morin</i>	
<u>INTEGRITY SERIES PANELS</u> <u>VERTICAL APPLICATION</u>	
X-12 PROFILE	
DWG. ISV1021E	

PANEL SUPPORT  
(NBM)

EXTRUSION FASTENER  
FOR TEMPORARY FASTENING

SUBGIRT FASTENER

SHIM AS REQUIRED

WEATHER-RESISTIVE BARRIER &  
AIR BARRIER (NBM)

1/2" DEEP SUBGIRT

FIELD CUT PANEL  
AS REQUIRED

CLOSURE  
FLASHING MK

EXPANSION  
JOINT (VARIES)

BELLOW WEATHER-RESISTIVE  
BARRIER & AIR BARRIER  
(NBM)

FLEXIBLE EXPANSION FLASH  
W/STAINLESS STEEL FLANGES

EXTRUSION & RETAINER  
FLASHING FASTENER

EXTERIOR SHEATHING  
(NBM)

PN-405C ENDWALL  
EXTRUSION

RETAINER  
FLASHING MK

PANEL RETAINER  
FASTENER

PN-405 ENDWALL  
EXTRUSION

SEALANT

NOTE: (NBM) = NOT BY MORIN

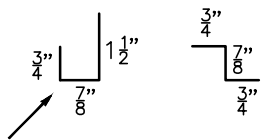

Morin

INTEGRITY SERIES PANELS  
VERTICAL APPLICATION

X-12 PROFILE

DWG. ISV1022E



WEATHER-RESISTIVE BARRIER  
& AIR BARRIER (NBM)

SELF ADHERING BUTYL  
FLASHING TAPE

PANEL CLIP &  
EXTRUSION  
FASTENER

PN-402 BASE EXTRUSION

$\frac{1}{4}$ "  
WEEP  
GAP

ROOFING MATERIAL  
(NBM)

PANEL SUPPORT  
(NBM)

EXTERIOR SHEATHING  
(NBM)

SUBGIRT FASTENER

$\frac{1}{2}$ " DEEP SUBGIRT

EXTRUSION FASTENER  
FOR TEMPORARY FASTENING

BACKER ROD  
& SEALANT

STRUCTURE  
(NBM)

NOTE: (NBM) = NOT BY MORIN

Morin

INTEGRITY SERIES PANELS  
VERTICAL APPLICATION

X-12 PROFILE

DWG. ISV1023E





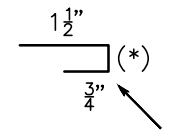

(\* ) PER FIELD CONDITIONS

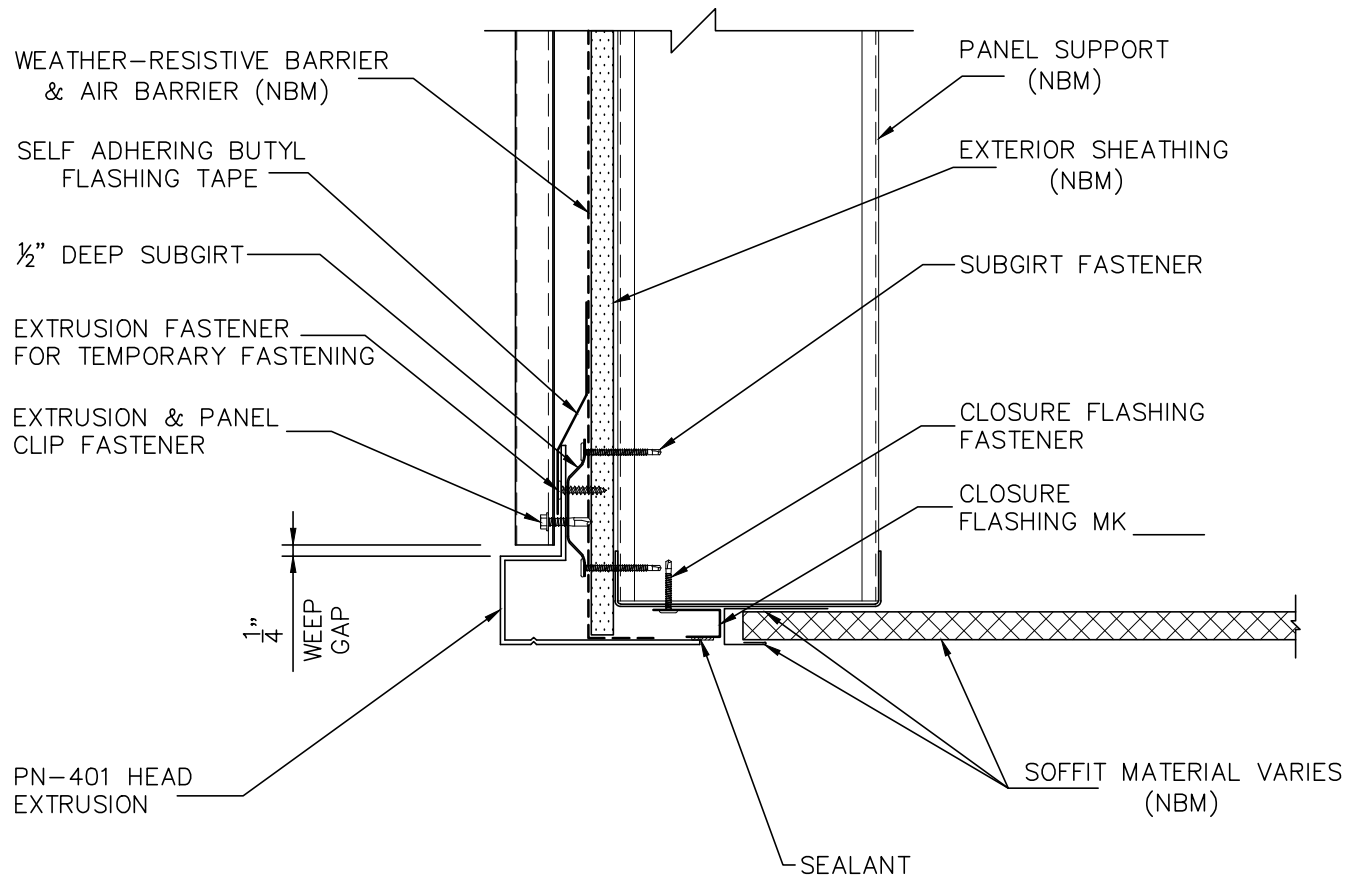

NOTE: (NBM) = NOT BY MORIN

<i>Morin</i>	
<u>INTEGRITY SERIES PANELS</u> <u>VERTICAL APPLICATION</u>	
X-12 PROFILE	
DWG. ISV1024E	